

SMART View PRO



INSTALLATION & USE

16 Port SMART View PRO SV16PRO



12 Port SMART View PRO SV12PRO



8 Port SMART View PRO SV8PRO



4 Port SMART View PRO SV4PRO

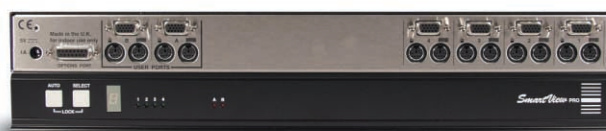

SMART View PRO

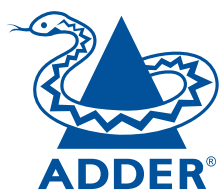

www.addertec.com

About this manual

SmartView Pro - Installation and Use

Fifth edition (March 1999)

Part No. ADD0031/5

(c) 1999 Adder Technology Ltd.

All rights reserved. Whilst every precaution has been taken in the preparation of this manual, Adder Technology Ltd assumes no responsibility for errors or omissions. Neither is any liability assumed for damages resulting from the use of the information contained herein. We reserve the right to change the specifications, functions and circuitry of the product without notice. All trademarks acknowledged.

Safety information

- For use in dry, oil free indoor environments only.
- Warning - live parts contained within power adapter.
- No user serviceable parts within power adapter - do not dismantle.
- Plug the power adapter into a socket outlet close to the SmartView.
- Replace the power adapter with a manufacturer approved type only.
- Do not use power adapter if power adapter case becomes damaged, cracked or broken or if you suspect that it is not operating properly.

Warranty

Adder Technology Ltd warrants that this product shall be free from defects in workmanship and materials for a period of one year from the date of original purchase. If the product should fail to operate correctly in normal use during the warranty period, Adder will replace or repair it free of charge. No liability can be accepted for damage due to misuse or circumstances outside Adder's control. Also Adder will not be responsible for any loss, damage or injury arising directly or indirectly from the use of this product. Adder's total liability under the terms of this warranty shall in all circumstances be limited to the replacement value of this product.

If any difficulty is experienced in the installation or use of this product that you are unable to resolve, please contact your supplier.

Radio Frequency Energy

Shielded cables must be used with this equipment to maintain compliance with radio frequency energy emission regulations and ensure a suitably high level of immunity to electromagnetic disturbances.

European EMC directive 89/336/EEC

This equipment has been tested and found to comply with the limits for a class B computing device in accordance with the specifications in the European standard EN55022. These limits are designed to provide reasonable protection against harmful interference. This equipment generates, uses and can radiate radio frequency energy and if not installed and used in accordance with the instructions may cause harmful interference to radio or television reception. However, there is no guarantee that harmful interference will not occur in a particular installation. If this equipment does cause interference to radio or television reception, which can be determined by turning the equipment on and off, the user is encouraged to correct the interference with one or more of the following measures: (a) Reorient or relocate the receiving antenna. (b) Increase the separation between the equipment and the receiver. (c) Connect the equipment to an outlet on a circuit different from that to which the receiver is connected. (d) Consult the supplier or an experienced radio / TV technician for help.

FCC Compliance Statement (United States)

This equipment generates, uses and can radiate radio frequency energy and if not installed and used properly, that is, in strict accordance with the manufacturer's instructions, may cause interference to radio communication. It has been tested and found to comply with the limits for a class A computing device in accordance with the specifications in Subpart J of part 15 of FCC rules, which are designed to provide reasonable protection against such interference when the equipment is operated in a commercial environment. Operation of this equipment in a residential area may cause interference, in which case the user at his own expense will be required to take whatever measures may be necessary to correct the interference. Changes or modifications not expressly approved by the manufacturer could void the user's authority to operate the equipment.

Canadian Department of Communications RFI statement

This equipment does not exceed the class A limits for radio noise emissions from digital apparatus set out in the radio interference regulations of the Canadian Department of Communications.

Le présent appareil numérique n'émet pas de bruits radioélectriques dépassant les limites applicables aux appareils numériques de la classe A prescrites dans le règlement sur le brouillage radioélectriques publié par le ministère des Communications du Canada.

Contents

1. Introduction	5
1.1 Key features	5
1.2 Package contents	6
1.3 Product information	7
2. Installation	11
2.1 What you will need	11
2.2 Mounting the SmartView	12
2.3 Connecting your devices	12
2.4 Configuring your PCs	13
2.5 Configuring the SmartView	13
2.6 Summary of SmartView configuration options	14
2.7 Other useful installation information	16
2.8 Re-enabling a disconnected PS/2 mouse	17
2.8 Hot plugging the SmartView into running systems and re-enabling disconnected PS/2 CPU mouse connections	17
3. Using the SmartView	19
3.1 Power on status	19
3.2 Status lights	19
3.3 Front panel keys and remote controller	19
3.4 Status display.....	21
3.5 Using the dual control ports (A and B)	22
3.6 Keyboard hotkey control	22
3.7 On screen menu control.....	24
3.8 Mouse control.....	27
3.9 RS232 control	27
3.10 Cascading SmartViews	27

4. SmartView configuration options	30
4.1 Screen saver time delay	30
4.2 Autoscan lock on mode and delay time	30
4.3 Timeout setting for switching between local and remote ports	31
4.4 Mouse mode and mouse switching of channels	32
4.5 Keyboard hotkey combination	33
4.6 Firmware functions (version query, mouse restore and reset)	34
4.7 Display appearance options	34
4.8 Setting a security password	35
4.9 Cascade query code	36
4.10 Exit configure mode	36

Appendices

A - Cable and connector specifications	37
B - Problem solving	39

1. Introduction

Thank you for purchasing the Adder SmartView Pro. Your SmartView Pro is a high performance keyboard, monitor and mouse sharing device which supports a wide range of PC hardware and software platforms.

1.1 Key features

- Control multiple PCs from a local and remote keyboard, monitor and mouse.
- On-screen menu allows computers to be selected by name.
- SmartBoot feature automatically boots all machines during power up.
- Duplicate control ports allow local and remote keyboard / monitor / mouse access.
- Mixed AT/PS2 keyboards and PS2/RS232 mice supported as standard.
- Can be cascaded to provide a video switching network.
- OVQ circuit ensures Optimum Video Quality even over extended distances.
- Password security prevents unauthorised use.
- Remote control module for convenient operation.
- Channel switching by on-screen display, front panel key, keyboard hotkey, or 3 button mouse.
- Automatically restores keyboard and mouse states when channel changed.
- Can be controlled remotely via an RS232 serial port.
- Supports high bandwidth monitors at resolutions up to 1600 x 1200.
- Supports keyboard modes 1,2 and 3 and mouse prompt and stream modes for maximum compatibility.
- Includes screen saver, auto-scan and variable hotkey options.
- Confirmation of selected ports on local and cascaded SmartViews.
- Support for Microsoft IntelliMouse.
- Mouse restoration functions to enable 'hot plugging' of certain systems.

1.2 Package contents

- SmartView Pro.
- Power supply suitable for your country.
- 6 x stick on self-adhesive rubber feet.
- 2 x mounting brackets for fixing the unit into a 19 inch rack.
- 4 x screws for fixing mounting brackets to SmartView Pro
(6 screws supplied with SV12PRO and SV16PRO models)
- This installation guide.

1.3 Product information

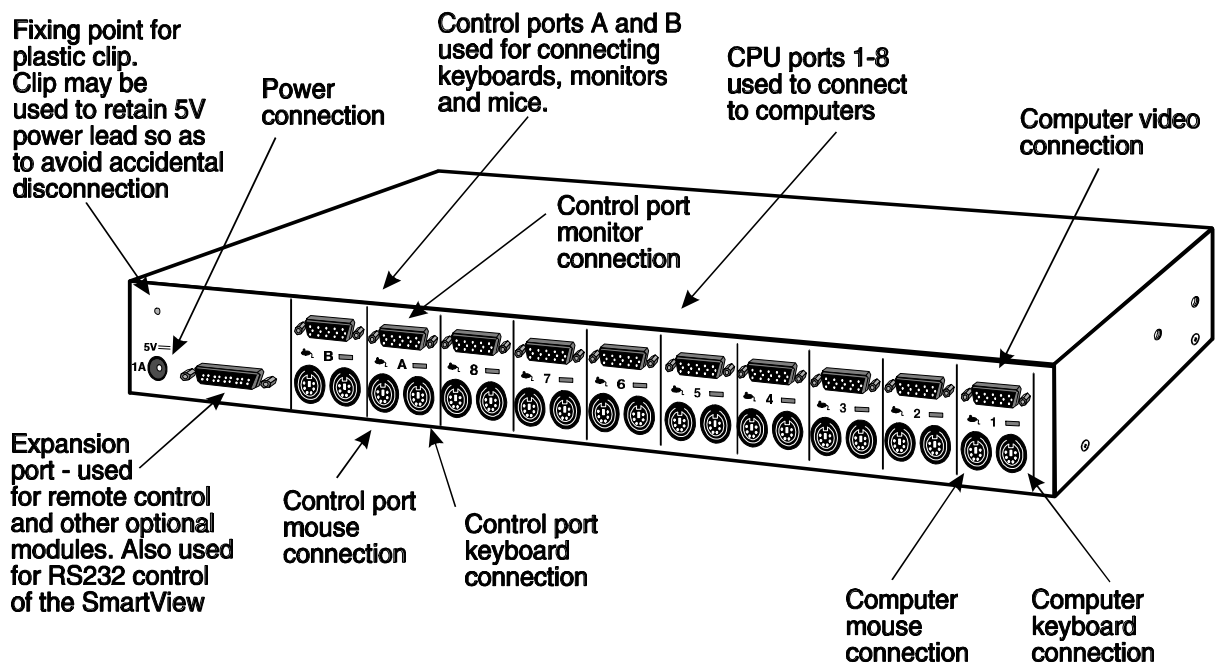
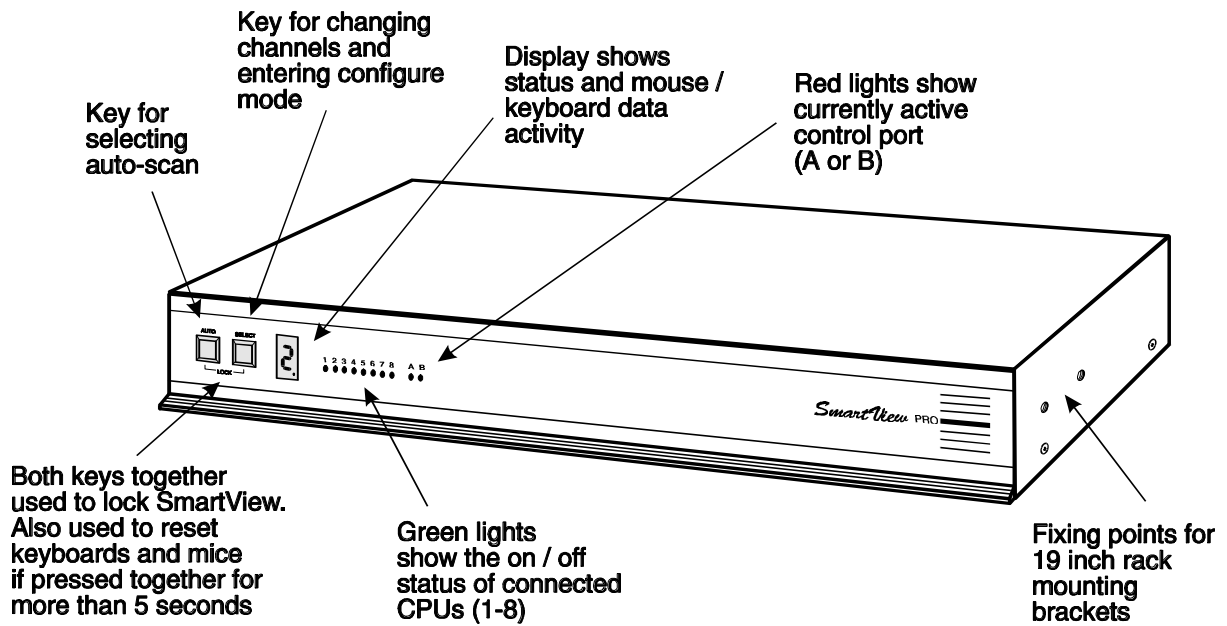

Fig. 1 - SmartView SV8PRO

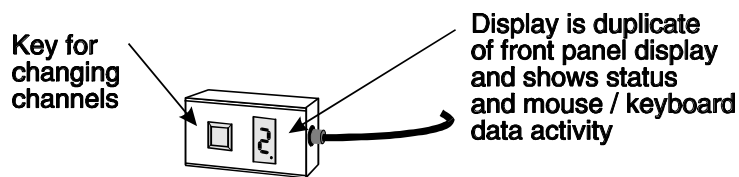

Fig. 2 - Remote control pad / display (optional accessory for 4 & 8 port models)

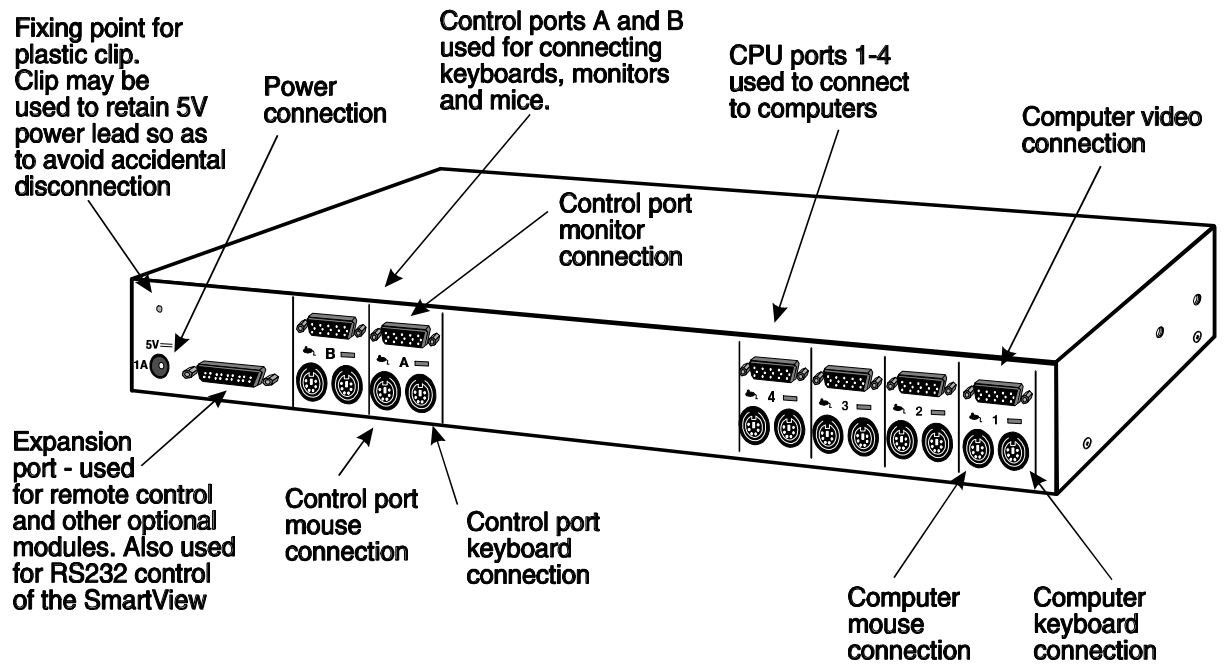
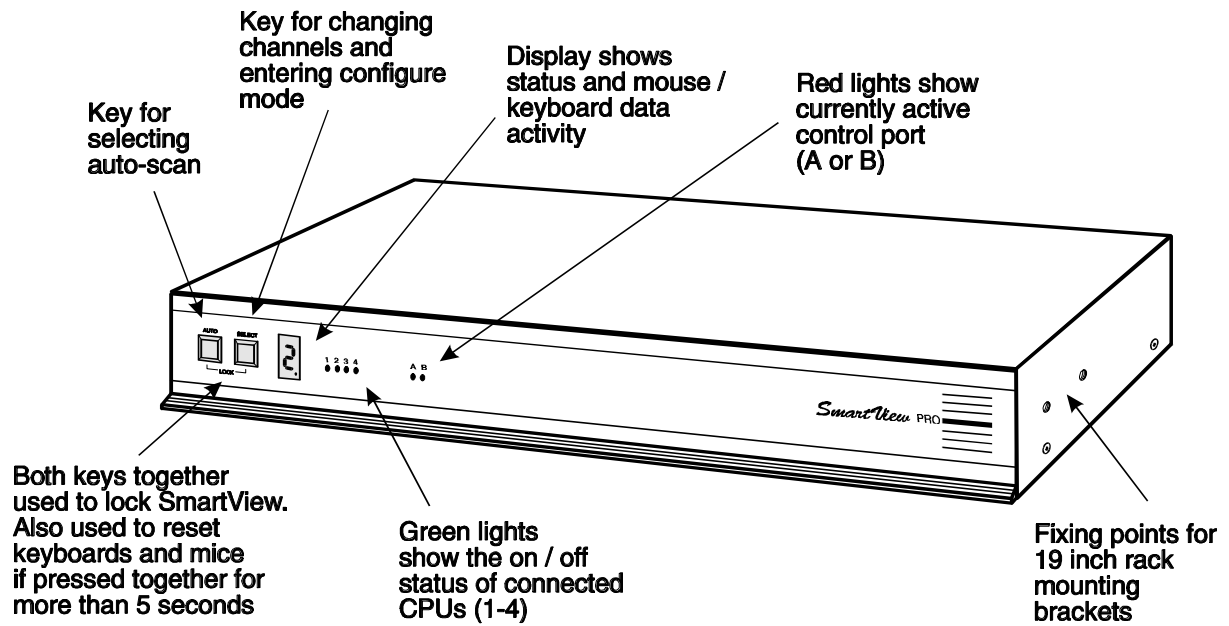

Fig. 3 - SmartView SV4PRO

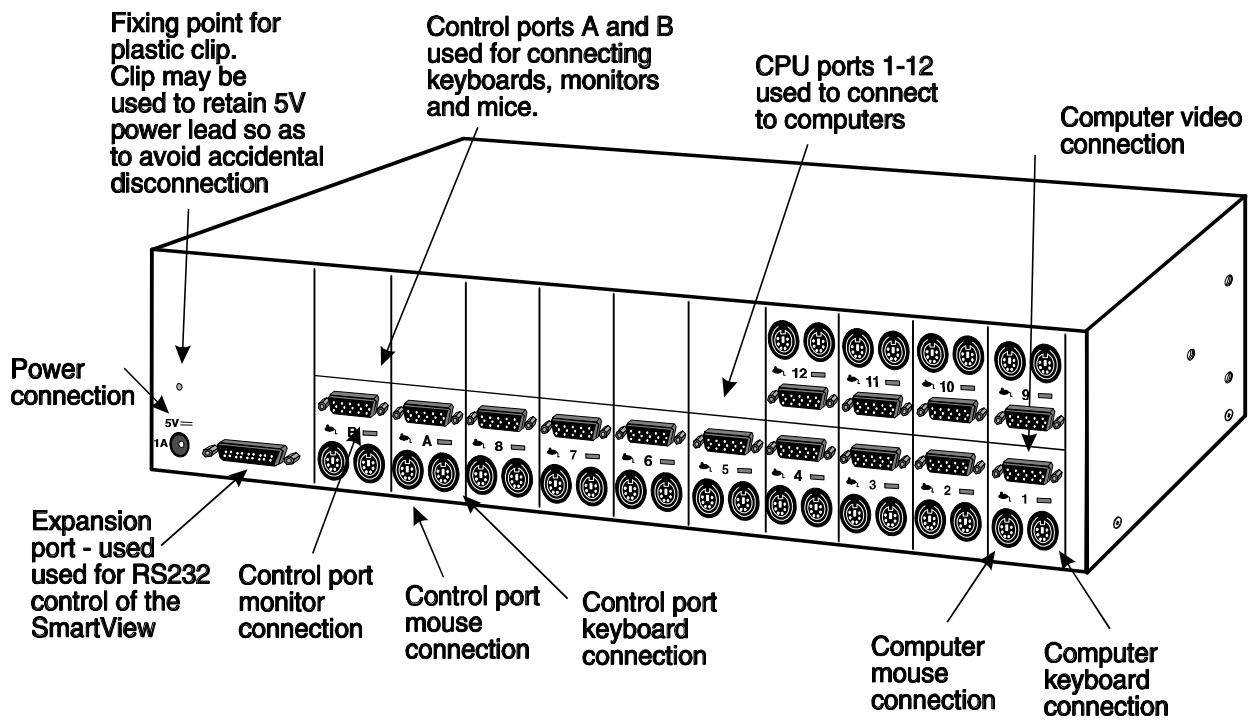
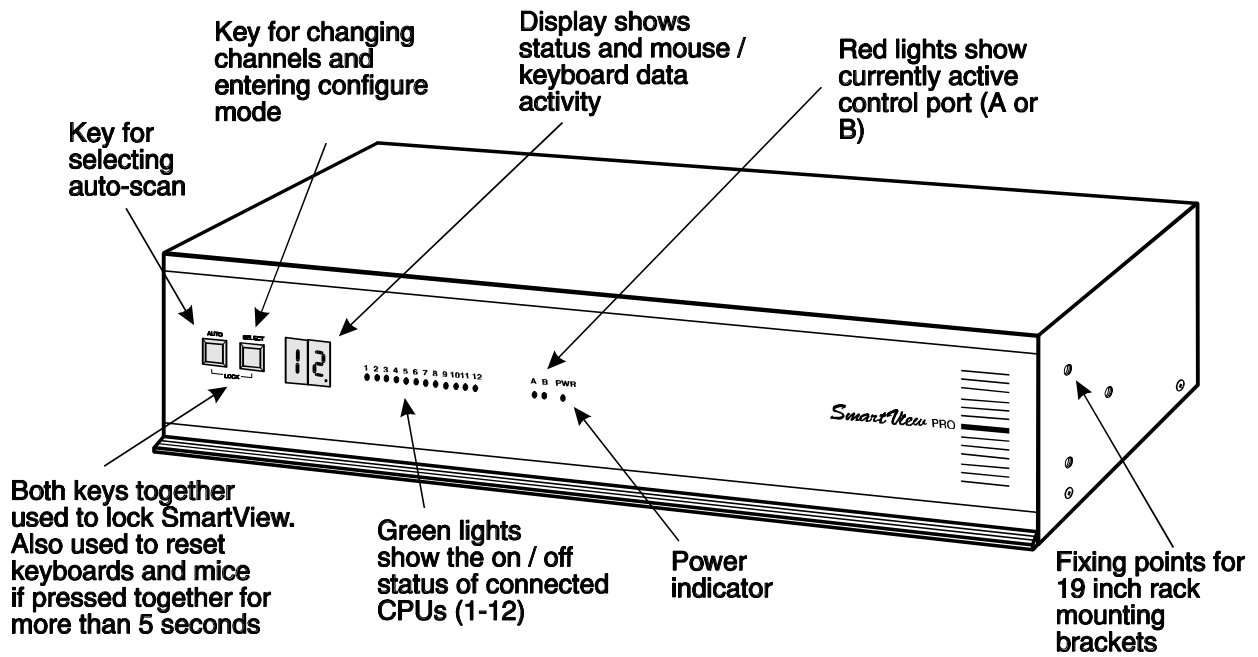

Fig. 4 - SmartView SV12PRO

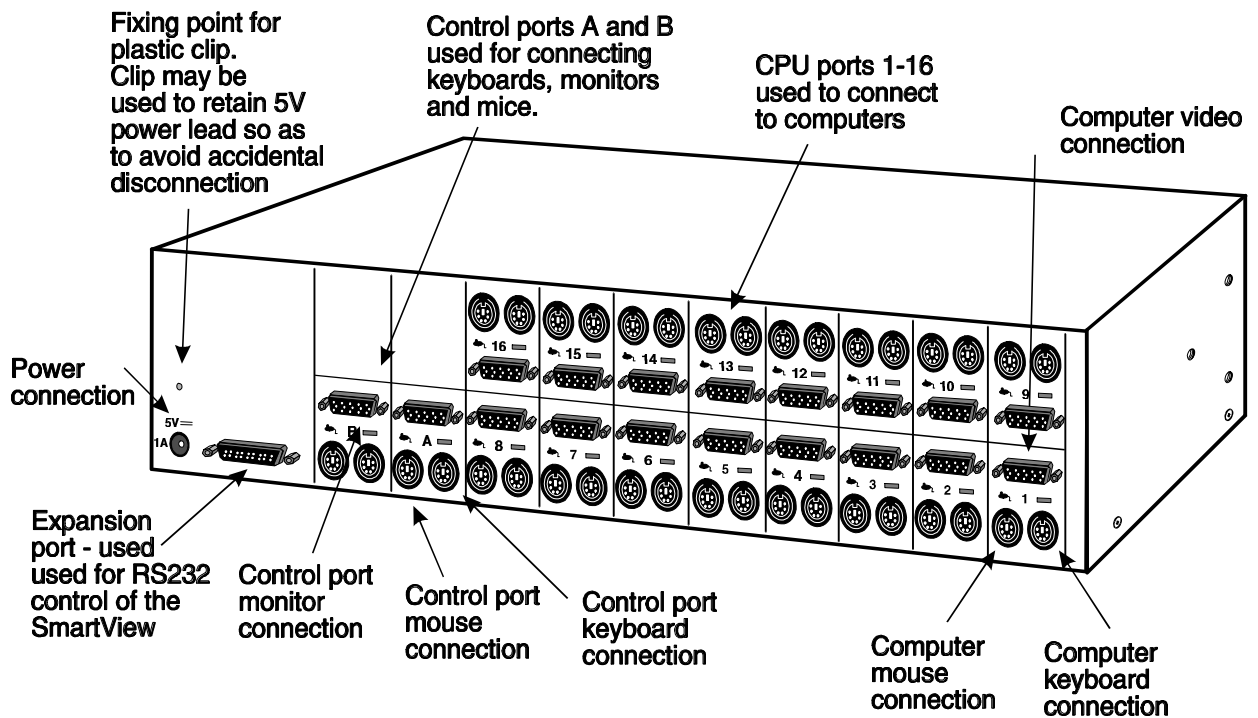
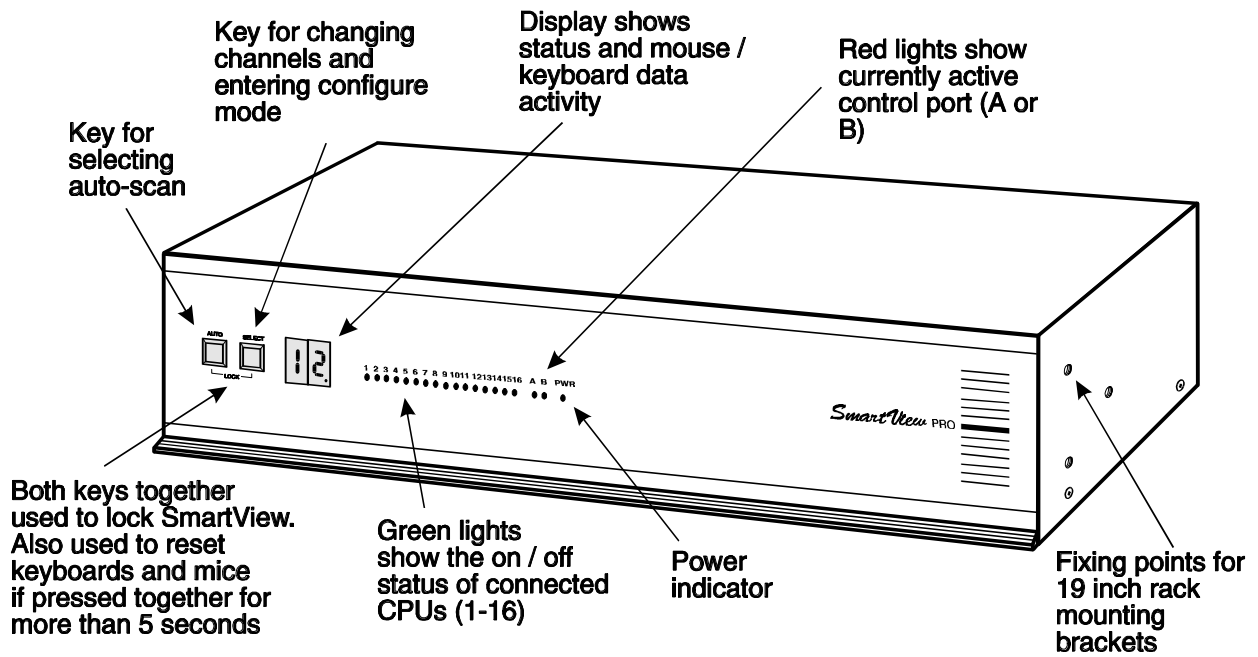

Fig. 5 - SmartView SV16PRO

2. Installation

2.1 What you will need

- Cables to connect the SmartView to each of your PC keyboard, video and mouse ports. Cable specifications are given in appendix A. (You do not need to connect a mouse cable if you are not using the mouse).
- A monitor with a standard VGA/SVGA (15 pin) connector that will work when connected directly to each of your PCs. SmartView supports low and high resolution monitors.
- A standard AT or PS/2 style keyboard. If you are using an AT keyboard with a 5 pin connector you may connect this to the SmartView using a standard AT to PS/2 keyboard adapter.
- A PS/2 style two or three button Microsoft or Logitech compatible mouse or a Microsoft IntelliMouse compatible mouse. If you wish to use the mouse to switch the SmartView's channel then you will need a three button mouse or an IntelliMouse.

(The SmartView supports 'Internet Mice' that are compatible with the Microsoft IntelliMouse. These are fitted with a wheel or other scroll control and sometimes have additional buttons. Examples are: Microsoft IntelliMouse, Logitech Pilot Mouse+, Logitech MouseMan+, Genius NetMouse and Genius NetMouse Pro.)

- A suitable mouse driver for your PCs. Supported types are:
 - PS/2 or RS232 two button mouse driver (any manufacturer).
 - Microsoft mouse driver (including IntelliMouse).
 - Logitech mouse driver (including two button, three button and wheel mouse)

Use of PS/2 and RS232 style mice with the SmartView - All of the mouse connections from SmartView to PCs support either a PS/2 or an RS232 mouse. SmartView automatically converts from the PS/2 mouse commands to RS232 serial mouse commands. Serial mice types are selected by using an adapter as described in Appendix A. The SmartView will operate without a mouse connected if you do not wish to use one.

2.2 Mounting the SmartView

The SmartView has been designed to be used either on a desktop or mounted in a 19 inch rack. If the SmartView is to be used on a desktop then you will need to stick the supplied self-adhesive rubber feet to the underside of the SmartView. If the SmartView is to be mounted in a 19 inch rack then you will need to fit the rack mounting brackets to the side of the SmartView. Do this using the brackets and screws provided.

2.3 Connecting your devices

Ensure that the power is disconnected from the SmartView and all devices which are to be attached. Connect the shared keyboard, PS/2 mouse and monitor to the connectors at the rear of the SmartView (see figs 1,2,3 & 4). You may connect your keyboard monitor and mouse to control port A or B. If you are connecting two sets of keyboards, monitors and mice then you do not need to use the same brands or mix of devices on each control port. For example, you may wish to use a two button PS/2 mouse on one port and a Microsoft IntelliMouse on the other. Next connect each computer system unit in turn with the keyboard cable, mouse cable and video cable. Any unused computer connections can be left unconnected. To connect computers with serial mouse connections and AT style keyboard connections use the adapters supplied in the cabling pack as shown below. Alternatively, if you have chosen not to purchase the cable pack, refer to appendix A for cable specifications.

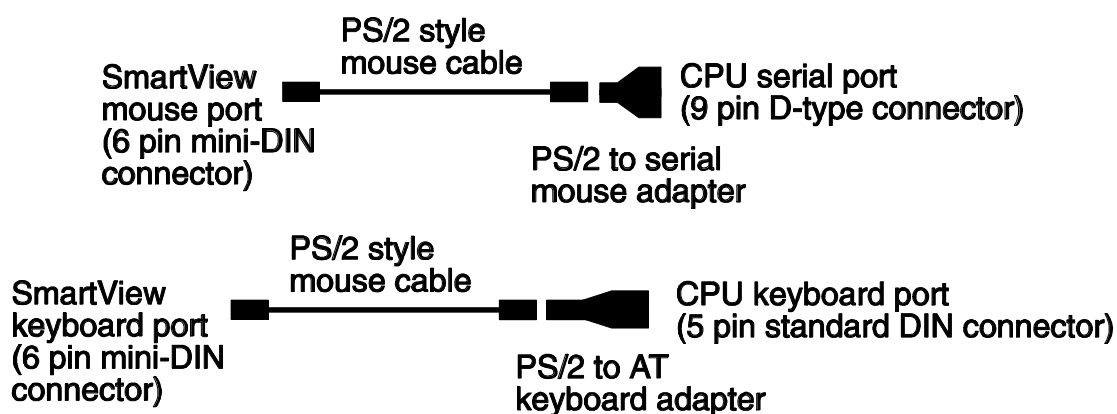

The SmartView is now ready for connection to the mains using the mains power adapter supplied. It is important to apply power to the SmartView first, then power on the monitor and each of the computers in turn. Failure to switch the SmartView and computers on in the correct order can lead to the mouse and/or keyboard not being recognised by the computers when they are switched on.

2.4 Configuring your PCs

Configure your PC in the same way that you would if your keyboard, mouse and monitor were all connected directly to your PC, but bearing in mind the following points:

- SmartView emulates Microsoft compatible serial, IntelliMouse and PS/2 mice, so ensure that your PC software is configured for a Microsoft mouse of the correct type. Refer to the list of supported drivers in section 2.1.
- SmartView supports VGA/SVGA/XGA/XGA2 type monitors, but does not support the automatic detection features available with some 'plug and play' monitors and video cards. If you have this type of video card and monitor, you should select the video mode manually instead of relying upon the automatic detection feature.

2.5 Configuring the SmartView

The SmartView is supplied pre-configured with factory defaults which are suitable for most applications. There are a number of more advanced options which can be set by the user. These are stored in the SmartView's EEPROM memory and are retained when the power is disconnected.

The options may be changed whilst the SmartView is in configure mode. You may enter configure mode at initial power on or whilst the SmartView is running:

To enter configure mode at power on:



Switch off all the attached PCs and the SmartView. Hold down the SELECT key whilst powering on the SmartView. Do not release the key until the SmartView displays 'C' to show that it has entered configure mode.



To enter configure mode whilst the SmartView is running:

Hold down the SELECT key for 5 seconds until the front panel display shows 'C'.

In configure mode, options are entered by typing a letter followed by a number followed by (enter). Use ESC to abort the entry of an option. The SmartView will remain in configure mode until you type 'E' (enter).

For example: to set hotkey option 2 type the following at the 'C' prompt

(at SmartView 'C' prompt)   

To exit configure mode type:  

2.6 Summary of SmartView configuration options

Full details of each of the configuration options and their uses are given in section 4.

B1 - screen saver disabled (default)

B2 - Blank screen after 1 minute of inactivity

B3 - Blank screen after 2 minutes of inactivity

B4 - Blank screen after 4 minutes of inactivity

B5 - Blank screen after 8 minutes of inactivity

B6 - Blank screen after 12 minutes of inactivity

B7 - Blank screen after 16 minutes of inactivity

B8 - Blank screen after 20 minutes of inactivity

D1 - Menu appears with magenta / blue background and green highlight (default)

D2 - Menu appears with red / blue background and green highlight

D3 - Menu appears with blue / black background and light blue highlight

D4 - Confirmation message remains on screen for standard time period (default)

D5 - Confirmation message remains on screen for short time period

D6 - Confirmation message remains on screen for extended time period

L1 - SmartView locks on to active ports only during autoscanning (default)

L2 - SmartView locks on to every port during autoscanning

L3 - SmartView powers on in autoscan mode and locks on to active ports only

L4 - SmartView powers on in autoscan mode and locks on to all ports

L7 - SmartView cascade query code = AD (default)

L8 - SmartView cascade query code = EF

- S1** - 2 seconds of inactivity before allowing switchover between A & B ports (default)
- S2** - 5 seconds of inactivity before allowing switchover between A & B ports
- S3** - 10 seconds of inactivity before allowing switchover between A & B ports
- S4** - 30 seconds of inactivity before allowing switchover between A & B ports
- S5** - 1 minute of inactivity before allowing switchover between A & B ports
- S6** - 5 minutes of inactivity before allowing switchover between A & B ports
- S7** - 10 minutes of inactivity before allowing switchover between A & B ports

- T1** - 2 seconds autoscan delay time before switching to next port (default)
- T2** - 5 seconds autoscan delay time before switching to next port
- T3** - 7 seconds autoscan delay time before switching to next port
- T4** - 10 seconds autoscan delay time before switching to next port
- T5** - 15 seconds autoscan delay time before switching to next port
- T6** - 20 seconds autoscan delay time before switching to next port
- T7** - 30 seconds autoscan delay time before switching to next port
- T8** - 60 seconds autoscan delay time before switching to next port

- U1** - SmartView channels are switchable using a 3 button mouse or IntelliMouse (default) (SmartView reports 2 button mouse mode to PCs)
- U2** - SmartView channels are not switchable using 3 button mouse or IntelliMouse (SmartView reports 2 button mouse mode to PCs)
- U3** - SmartView channels are not switchable using 3 button mouse or IntelliMouse (SmartView reports 3 button mouse mode to PCs)
- U4** - SmartView channels are switchable using 3 button mouse or IntelliMouse (SmartView reports IntelliMouse mode to PCs)
- U5** - SmartView channels are not switchable using 3 button mouse or IntelliMouse (SmartView reports IntelliMouse mode to PCs)

- H1** - Hotkey combination is CTRL + ALT + command key (default)
- H2** - Hotkey combination is CTRL + SHIFT + command key
- H3** - Hotkey combination is ALT + SHIFT + command key
- H4** - Hotkey combination is RIGHT ALT + command key
- H5** - Hotkey combination is LEFT ALT + RIGHT ALT + command key
- H6** - Hotkey combination is LEFT CTRL + LEFT ALT + command key
- H7** - Hotkey combination is RIGHT CTRL + RIGHT ALT + command key
- H8** - No hotkey combination enabled

F1 - Display firmware first digit
F2 - Display firmware second digit
F3 - Display firmware third digit
F5 - Restore PS/2 mouse function
F6 - Restore IntelliMouse function
F8 - RESET all configurations to default settings. (Display confirms with 'r').

P - Sets password - see section 4.8 for instructions.

E - Exits configure mode and returns the SmartView to normal operation mode.

2.7 Other useful installation information

PC boot up sequence - When your PCs are powered on they communicate with any attached keyboards and mice and setup parameters required by the particular operating system. It is necessary for the SmartView to be attached and powered on during this sequence so that it can give the required responses and keep track of all the modes and settings requested by each of the connected PCs.

Mouse characteristics - do not unplug a PS/2 mouse connection from a PC whilst the PC is on. Due to the design of PS/2 mice communications the mouse function on the PC will be lost and you will have to re-boot the PC to regain normal operation. Unplugging the mouse from the SmartView will also cause it to stop operating when it is plugged back in. RS232 mice can usually be unplugged and plugged back in provided that a mouse was connected when the operating system initially booted. The SmartView is fitted with a PS/2 mouse recovery system which allows you to disconnect and re-connect the shared mouse without powering down the system (although this is generally not advisable) - see section 2.8 for details.

Keyboard and mouse mode switching - The SmartView keeps a log of the keyboard and mouse mode and resolution settings requested by each of the connected PCs. These settings are automatically restored to the shared keyboard and mouse when the SmartView channel is switched thus ensuring maximum software compatibility. The keyboard num, caps and scroll lock states are an obvious example of this process.

2.8 Re-enabling a disconnected PS/2 mouse

If you disconnect the shared PS/2 mouse from the SmartView by accident during operation then the mouse operation will be lost when the mouse is plugged back in. To avoid having to reboot the entire system in this situation the SmartView is fitted with an automatic mouse recovery system.

With the PS/2 mouse disconnected, change the channel using the keypad or keyboard hotkeys. The SmartView detects that the mouse has been disconnected and triggers the automatic recovery system. Plug in the PS/2 mouse and the SmartView will re-initialise it.

Alternatively you can reset the keyboards and mice by holding the SELECT and AUTO keys down together for 5 seconds. A complete power off reset of the connected keyboards and mice will then be performed. This function only resets the shared keyboard and mice that are plugged into ports A and B. It does not affect the status of any of the other ports on the switch or the CPU connections.

2.9 Hot plugging the SmartView into running systems and re-enabling disconnected CPU PS/2 mouse connections

It is advisable to switch off the systems that are going to be connected to the SmartView before installation. However if this is not possible then most systems can be hot plugged by using the SmartView's mouse restoration functions. The keyboard connection will normally restore itself automatically.

On many PCs, mouse movement will be lost if the PS/2 mouse is unplugged and plugged back in whilst the PC is running. Mouse movement can then only be restored by rebooting the PC. This is because the mouse drivers only setup and enable the mouse when the PC is initially booted.

If you have switched off your SmartView or you are attempting to 'hot plug' it into a system that is already running, you may be able to restore lost mouse movement using the SmartView's mouse restoration functions.

Mouse restoration functions should be used with care as unpredictable results may occur if the wrong mouse type is selected. If in doubt restore the mouse by powering down the PC normally.

Standard PS/2 mouse data uses a different data format to IntelliMouse data and so two reset functions are provided on the SmartView. The type of data format expected by the PC depends upon the driver and the type of mouse that was connected when the driver was booted. The following table may be used as a guide. Note that the mouse reset functions predict the likely mouse resolution settings but may not restore the speed or sensitivity of the mouse exactly as they were when the PC originally booted.

Type of mouse / system Connected at bootup	Driver type	Likely expected data format	Suggested restoration
PS/2	PS/2 only	PS/2	F5
PS/2	IntelliMouse	PS/2	F5
IntelliMouse / SmartView	PS/2 only	PS/2	F5
IntelliMouse / SmartView	IntelliMouse	IntelliMouse	F6

To restore lost mouse movement on a CPU connected to the SmartView:

- 1) Select the CPU that has lost its mouse movement
- 2) Press the select key on the front of the SmartView for 5 seconds until 'C' is displayed. You are now in configure mode.
- 3) To restore a PS/2 mouse connection press



Or, to restore an IntelliMouse connection press



- 4) Exit from configure mode by typing



- 5) Test the mouse movement by moving the mouse a short distance.

F5 - Restore PS/2 mouse function

F6 - Restore IntelliMouse function

3. Using the SmartView

This section explains the general operation of the SmartView. We recommend that you read this section before starting to use the product.

3.1 Power on status

At power on the SmartView selects PC number 1 and displays '1'. If a password has been set then 'P' will be displayed and the SmartView will remain locked until a valid password is entered. The 12 and 16 port models are also fitted with a power indicator.

3.2 Status lights

The green CPU status lights (1-16) show the on/off status of the connected CPUs. This status is derived from the CPU keyboard connection and operates even when the SmartView is powered off.

The red status lights (A and B) show the activity status of the local and remote keyboard / monitor / mouse control ports. When port A is active port B is disabled and vice versa. A port becomes active and the associated light comes on when keyboard or mouse data activity has been detected. When no keyboard or mouse data has been detected for the timeout period (see section 4.3) the port becomes inactive, the light goes out and the other port can then be used.

3.3 Front panel keys and remote controller

SELECT key

The SELECT key is used to select which channel is currently controlled by the shared keyboard, mouse and monitor ports. It is also used to enter configuration mode (see section 2.5). Pressing the key during normal operation will cause the next channel to be selected.

The SELECT key can also be used to access the SmartView's configuration mode (see section 2.5). To do this press the key and hold it down for 5 seconds until 'C' appears on the SmartView's front panel display.

An optional remote controller is also available for the SV4PRO and SV8PRO models which replicates the SELECT key and display, but can be located remotely from the SmartView. This is particularly useful in applications where the SmartView is located away from the desktop. The remote controller can be conveniently attached to your keyboard with a couple of Velcro strips to give instant channel information and key control.

AUTO key

The AUTO key puts the SmartView into auto-scan mode. The ports scanned and the scan time can be selected by options L and T in configure mode (see section 4.2).

AUTO and SELECT keys pressed together (Lock function)

Pressing the AUTO and SELECT keys together will cause the SmartView to select channel 0 and disable all video output. If a security password has been set then the SmartView will lock, display P and wait for the password to be entered before unlocking the SmartView.

AUTO and SELECT keys pressed together for 5 seconds (keyboard and mouse reset function)

After 5 seconds the SmartView's display will blank and power to the shared keyboards and mice will be switched off causing a complete reset of these devices. After several further seconds the power will be re-applied and normal operation is resumed. This reset function does not reset the computer connections to the SmartView.

3.4 Status display

The status display usually shows the currently selected port. If autoscan mode is selected, the segments will illuminate in sequence in a clockwise direction interspersed with a display of the currently selected channel. If SmartView has been locked, 'P' will be displayed until a valid password has been typed to unlock the unit. Data flow from the mouse or keyboard causes the dot to flash.

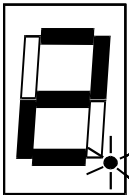
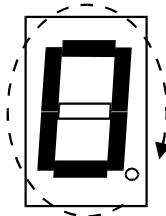
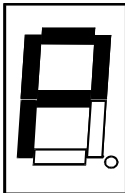
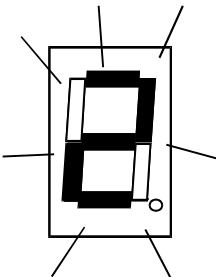
DISPLAY SHOWS		MEANING
Channel number displayed and dot in lower right hand corner flashes (0 indicates SmartView is disabled)		Activity on keyboard or mouse
Illuminated segment shifts clockwise with port number shown after each scan round		Auto-scan mode - scanning from channel to channel at rate as programmed by user
'P' prompt		Locked mode waiting for password to be entered
Display flashes port number		SmartView is in screen save mode - keyboard, mouse or keypad activity will re-enable the video

3.5 Using the dual control ports (A and B)

The SmartView is fitted with two control ports, A and B. Each control port has a keyboard, mouse and monitor connection. Either control port may be used to access the SmartView. Typically port A may be used for local access and port B for remote access (up to 20 metres away). The video picture is duplicated on both ports and the SmartView will accept keyboard and mouse data from one control port at a time. Whilst the other port is active, the num, caps and scroll lock keys on the inactive control port's keyboard will flash indicating that the port is currently disabled. Once there has been no keyboard or mouse data on the active control port for the timeout period, the other keyboard can be used. Once activity is detected then this new port becomes the active port and the other port is disabled. The currently active port is indicated on the front panel. If neither the A or B lights are on then either control port may be used.

3.6 Keyboard hotkey control

SmartView can be conveniently controlled by selecting channel, autoscan mode or security locking from the keyboard. All of the hotkey control commands are invoked by holding down the two hotkeys and then pressing a command key. By default, the two hotkeys are 'CTRL' and 'ALT', although other combinations can be selected by reconfiguring the hotkeys (see section 4.5). Once the hotkey command has been activated you will need to release the hotkeys and the command key before a new hotkey command is accepted by the SmartView. HOTKEYS + TAB is an exception and this allows you to 'tab through' the ports by holding down the hotkeys and repeatedly pressing TAB.

The hotkey command are summarised below (note that the numbers on the numeric keypad do not form part of a valid hotkey) :

- 'HOTKEYs' and '1'** - selects channel 1
- 'HOTKEYs' and '2'** - selects channel 2
- 'HOTKEYs' and '3'** - selects channel 3
- 'HOTKEYs' and '4'** - selects channel 4
- 'HOTKEYs' and '5'** - selects channel 5 (8,12 & 16 port models only)
- 'HOTKEYs' and '6'** - selects channel 6 (8,12 & 16 port models only)
- 'HOTKEYs' and '7'** - selects channel 7 (8,12 & 16 port models only)
- 'HOTKEYs' and '8'** - selects channel 8 (8,12 & 16 port models only)

'HOTKEYs' and '9' - selects channel 9	(12 & 16 port models only)
'HOTKEYs' and '1 then 0' - selects channel 10	(12 & 16 port models only)
'HOTKEYs' and '1 then 1' - selects channel 11	(12 & 16 port models only)
'HOTKEYs' and '1 then 2' - selects channel 12	(12 & 16 port models only)
'HOTKEYs' and '1 then 3' - selects channel 13	(16 port models only)
'HOTKEYs' and '1 then 4' - selects channel 14	(16 port models only)
'HOTKEYs' and '1 then 5' - selects channel 15	(16 port models only)
'HOTKEYs' and '1 then 6' - selects channel 16	(16 port models only)

'HOTKEYs' and 'TAB' - selects the next channel

'HOTKEYs' and 'M' - displays the on screen menu for selecting computers by name

'HOTKEYs' and 'A' - selects autoscan mode where each channel is displayed for the selected time (see section 4.3). To cancel autoscan mode simply select any fixed channel either by hotkey or using the SmartView button.

'HOTKEYs' and '0' – switches off the video signal and displays 0. This will cause some monitors to go into standby mode or switch off. The video signal can be re-enabled by selecting a channel.

'HOTKEYs' and 'L' - disables the SmartView's shared keyboard and mouse and displays 0. The video signal is switched off. If a password has not been set then the SmartView can be re-enabled by selecting a channel. If a password has been set then the SmartView displays 'P' to indicate that a valid password must be entered to unlock the switch. Simply type the same key combination as was set during configuration (see section 4.8) followed by the (enter) key. Note - if anyone has typed at the keyboard whilst in secure mode, it will be necessary to type (enter) first to clear the invalid password, then type the valid password followed by (enter) again.











'HOTKEYs' and '0 then {number}' – (where {number} is 0,1,2,3,4,5,6,7,8 or 9). Selects the channel specified by {number}. This allows ports on cascaded units to be selected. For example HOTKEYs + 0 10216 would select port 1 (01) on the current SmartView, port 2 (02) on the next cascaded SmartView and port 16 on the last SmartView.

Examples of common hotkey sequences (assuming CTRL + ALT hotkey option):









To select channel 2:

press    release   

To 'tab through' channels:

press    release  press 
release  press  release   

To select channel 12 (on a 12 or 16 port SmartView):

press    release 
press  release   

3.7 On Screen Menu control

SmartView Pro can conveniently select a computer using the integral On Screen Menu control. The menu is called up by pressing the two 'HOTKEYS' and 'M'. When the menu is first called up, there will be no named computers listed. You must first enter the names and port numbers for computers which are to be selected from the menu.

ADDER SMARTVIEW PRO	
Computer	Port
NT Server A	355
NT Server B	356
Local IBM PC	1
Local Compaq PC	2 <input checked="" type="radio"/>
Web Browser	4
Comms Server A	5
Comms Server B	6
Fred's PC	7

Dot shows currently selected computer

On-Screen menu (models SV4PRO and SV8PRO)
Port numbers are entered as single digits

ADDER SMARTVIEW PRO	
Computer	Port
NT Server A	030505
NT Server B	030506
Local IBM PC	01
Local Compaq PC	02 <input checked="" type="radio"/>
Web Browser	04
Comms Server A	05
Comms Server B	06
Jim's PC	12

Dot shows currently selected computer

On-Screen menu (models SV12PRO and SV16PRO)
Port numbers are entered as double digits with leading zeros where required

Adding a computer to the menu list

With the menu visible on the screen, press the INSERT key. This will cause a new *Computer* entry field to be inserted on the menu. This is highlighted in red with a flashing cursor to indicate the text entry position. Type in a name up to 16 characters long. You can use upper/lower case, special and space characters. When completed press the ENTER key. The red highlighted area now moves into the *Port*

entry field and you can enter the port number for the named Computer. Port numbers are specified using single digits on the 4 and 8 port models and double digits on the 12 and 16 port models (adding a leading 0 if necessary). If you are using cascaded SmartView Pro units, the cascade routing will need to be entered (see section 3.10 for more details). To specify port 5 on a SmartView that is cascaded off port 3 you would enter port number 35 (4 & 8 port products) or 0305 (12 and 16 port products). Units can be cascaded three levels deep.

Now press ENTER again to complete the entry and store it in the menu memory.

Note that you can add another Computer to the menu list at any time. If you just use the INSERT key, the entry will be placed after the current line. To place an entry before the current line use SHIFT and INSERT together, then edit the new name as already described.

Deleting a computer from the menu list

With the menu visible on the screen, highlight the computer to be deleted and press the DELETE key. To confirm deletion press ENTER. To abandon deletion press ESC.

Editing a computer on the menu list

With the menu visible on the screen, highlight the computer to be edited and press the SHIFT and DELETE keys together. Type in the new Computer name and port then press ENTER. To abandon editing press ESC.

Selecting a computer on the menu list

With the menu visible on the screen, highlight the computer to be selected using the cursor up/down or page up/down keys as required. Press the ENTER key to switch to the highlighted computer. SmartView Pro has an advanced 'connection confirmation' facility which is particularly useful in systems where many computers are displaying the same or very similar video. The selected computer name and port number will briefly flash up on the screen to confirm the selection has been made. If it is not possible to make the connection, perhaps because a cascaded unit is not switched on or is in use locally, the menu will flash 'computer unavailable' until the ESC key is pressed.

Summary of keys used by the menu and their function

'HOTKEYS' and 'M' - calls the menu up onto the screen (even if no PC video exists)

'INSERT' - adds a computer entry AFTER the currently selected line

'SHIFT' and 'INSERT' - adds a computer entry BEFORE the currently selected line

'DELETE' - deletes the currently selected computer

'SHIFT' and 'DELETE' - edits the currently selected computer

'ENTER' - confirms an entry or selects a computer

'ESC' - quits from editing a line or quits from the menu

'up arrow' - moves up the menu by one line

'down arrow' - moves down the menu by one line

'page up' - moves to the top of the menu page, or up 8 lines if more than 8 present

'page down' - moves to bottom of page or down 8 lines if more than 8 present

3.8 Mouse control

The channels can conveniently be changed on SmartView Pro by using a three button mouse or IntelliMouse. In order to switch to the next channel simply hold down the central mouse button or wheel button and click on the left hand mouse button. The channel will then change.

3.9 RS232 control

SmartView Pro can be controlled by a remote RS232 device. To select a channel the data rate of the sending device must be set to 1200 baud, 8 bits, no parity and 1 stop bit. No handshaking is used by the SmartView Pro. Simply send the character for the channel which needs to be selected, for example ASCII '1' (hex code 31) will select channel 1, ASCII '2' (hex code 32) will select channel 2 and so on. Ports 10,11,12,13,14,15 and 16 are selected by sending ASCII codes A,B,C,D,E,F and G respectively.

3.10 Cascading SmartViews



Any number of SmartView Pro switches can be connected together to expand the number of connected computers. This can be particularly useful where clusters of computers are located some distance from each other because each unit acts as data booster and can each be up to 30 metres away from the next SmartView. The channel can be selected on remote SmartView units using an extension of the HOTKEY control function or using the On Screen Menu which will store over 300

names. The On Screen Menu is recommended for selecting computers on cascaded SmartViews as this avoids the need to use long hotkey sequences that may be hard to remember. When using the On Screen Menu, limit the cascade depth to three levels (the maximum number of port digits that can be added to the menu).

For example, consider a situation where two SmartView Pro units are connected together as shown below. To connect to the computer attached to port 3 on SmartView B the user would hold down the hotkey keys then press '2' followed by '3', whilst keeping the hotkey keys pressed. This will have the effect of connecting to port '3' of the SmartView which is connected into port '2' of the first SmartView unit A. (note: if you are cascading 12 and 16 port units then you will need to type a leading 0 before all single digit port numbers).

For example to connect to port 3 on the SmartView SV8PRO cascaded off port 2 of your first SmartView SV8PRO use:

press    release 

press  release   

For example to connect to port 14 on the SmartView SV16PRO cascaded off port 1 of your first SmartView SV16PRO use:

press    release 

press  release 

press  release 

press  release   

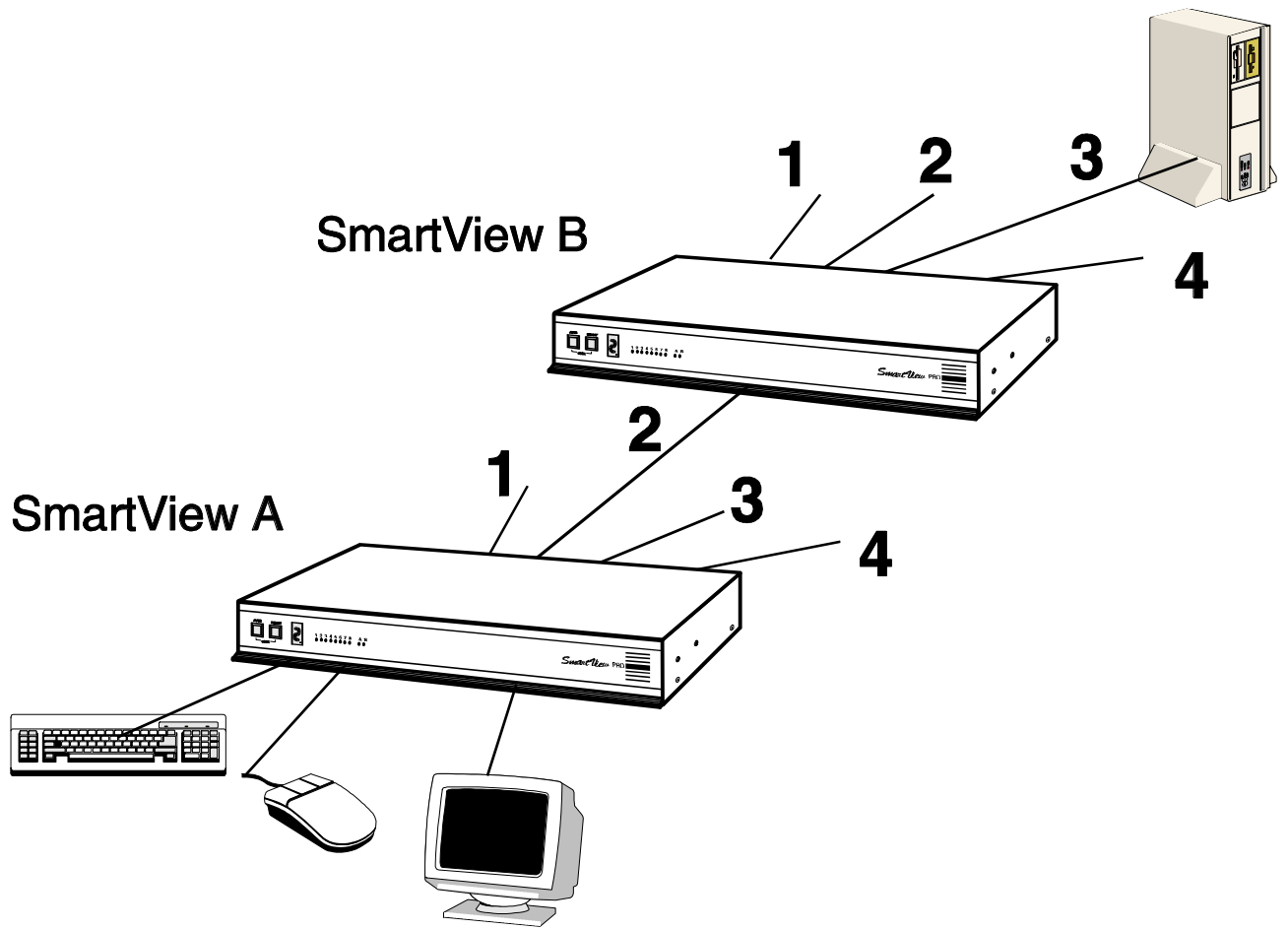

A typical cascade of two SmartViews

4. SmartView configuration options

All the options described in this section are entered in SmartView configure mode - see section 2.5 for instructions on entering configure mode.

4.1 Screen saver time delay

SmartView contains a programmable screen saver which will blank the display after the set time delay with no keyboard or mouse activity. Simply typing at the keyboard or moving the mouse will re-enable the display. The display will flash whilst the SmartView is in screen save mode.

B1 - screen saver disabled (default)

B2 - Blank screen after 1 minute of inactivity

B3 - Blank screen after 2 minutes of inactivity

B4 - Blank screen after 4 minutes of inactivity

B5 - Blank screen after 8 minutes of inactivity

B6 - Blank screen after 12 minutes of inactivity

B7 - Blank screen after 16 minutes of inactivity

B8 - Blank screen after 20 minutes of inactivity

4.2 Autoscan 'lock on' mode and delay time

SmartView can be set to select each channel in turn for a period of time set by the Autoscan delay time. Autoscan mode is entered by typing the hotkey keys together with 'A'. By default, only those channels which have a powered up computer connected to them will be scanned. Sometimes it may be desirable to scan all channels, even if the attached computer is switched off (this will simply show a blank screen when it is selected). All the SmartView's ports will be scanned if option L2 is selected. Some applications may also require the SmartView to power on in autoscan mode. This feature can be selected using the L3 or L4 options.

- L1 - SmartView only locks on to active ports during autoscanning (default)
- L2 - SmartView locks on to every port in turn during autoscanning
- L3 - SmartView powers on in autoscan mode and locks on to active ports only
- L4 - SmartView powers on in autoscan mode and locks on to all ports

- T1 - 2 seconds autoscan delay time before switching to next port (default)
- T2 - 5 seconds autoscan delay time before switching to next port
- T3 - 7 seconds autoscan delay time before switching to next port
- T4 - 10 seconds autoscan delay time before switching to next port
- T5 - 15 seconds autoscan delay time before switching to next port
- T6 - 20 seconds autoscan delay time before switching to next port
- T7 - 30 seconds autoscan delay time before switching to next port
- T8 - 60 seconds autoscan delay time before switching to next port

note: Autoscan mode is ended simply by selecting a fixed channel using the on-screen menu, the keypad, the keyboard hotkeys or the mouse.

Many modern monitors are fitted with automatic power save relays and will switch off after a few seconds if connected to an inactive PC. If you are using such a monitor you must not use the L2 feature. Constant switching on and off of your monitor's relay will eventually damage your monitor.

4.3 Timeout setting for switching between the local and remote keyboard/mouse ports (A and B)

If you are controlling the SmartView from two locations then you will have connected keyboards, monitors and mice to the local and remote ports (A and B). The SmartView will accept keyboard and mouse data from either location and the video is duplicated on both monitors. Only one of the ports may be used at a time. The other port is automatically disabled although the video continues to be displayed. This port is re-enabled for keyboard and mouse data when there has been no activity from the currently active port for the switchover timeout period. This timeout period is selectable from 2 seconds to 10 minutes using the 'S' options in configure mode as follows:

- S1 - 2 seconds of inactivity before allowing switchover between A & B ports (default)
- S2 - 5 seconds of inactivity before allowing switchover between A & B ports
- S3 - 10 seconds of inactivity before allowing switchover between A & B ports
- S4 - 30 seconds of inactivity before allowing switchover between A & B ports
- S5 - 1 minute of inactivity before allowing switchover between A & B ports
- S6 - 5 minutes of inactivity before allowing switchover between A & B ports
- S7 - 10 minutes of inactivity before allowing switchover between A & B ports

4.4 Mouse mode and mouse switching of channels

A three button PS/2 mouse or an IntelliMouse can be used to switch channels on the SmartView by default. To switch to the next channel, the user simply holds down the central button or wheel button and presses the left hand button to change channel. If the user does not wish to take advantage of this feature, it can be disabled by selecting U2, U3 or U5. If the third button is being used to switch the SmartView then it is not available for use with PC software although the function of an IntelliMouse wheel is not affected. Consequently in modes U1, U2 and U4 the SmartView reports to the PCs that a 2 button mouse is connected. If you wish to use the full function of a 3 button mouse or IntelliMouse for your PC software then you should select options U3 or U5.

The SmartView supports 'Internet Mice' that are compatible with the Microsoft IntelliMouse. These are fitted with a wheel or other scroll control and sometimes have additional buttons. Examples are:

- Microsoft IntelliMouse
- Logitech Pilot Mouse +
- Logitech MouseMan+
- Genius NetMouse
- Genius NetMouse Pro

Standard PS/2 and IntelliMouse compatible mice can be connected to control ports A and B in any combination. You may configure your CPUs using Microsoft PS/2 or IntelliMouse drivers in any combination as required. The IntelliMouse features are supported on both PS/2 and RS232 CPU connections. When using PS/2 CPU connections, the SmartView will automatically configure itself to the type of mouse requested by the driver. If you are using RS232 CPU connections then you will need to select mouse options U4 or U5 to enable the IntelliMouse features.

- U1 - SmartView channels are switchable using a 3 button mouse or IntelliMouse (default)
(SmartView reports 2 button mouse mode to PCs)
- U2 - SmartView channels are not switchable using 3 button mouse or IntelliMouse
(SmartView reports 2 button mouse mode to PCs)
- U3 - SmartView channels are not switchable using 3 button mouse or IntelliMouse
(SmartView reports 3 button mouse mode to PCs)
- U4 - SmartView channels are switchable using 3 button mouse or IntelliMouse
(SmartView reports IntelliMouse mode to PCs)
- U5 - SmartView channels are not switchable using 3 button mouse or IntelliMouse
(SmartView reports IntelliMouse mode to PCs)

4.5 Keyboard hotkey combination

The keyboard hotkey combination is used to change a channel, set autoscan mode or secure the product (so that the password needs to be typed before it can be used again). The following keyboard hotkey combinations can be selected. These hotkey combinations are used together with the command keys to trigger the required SmartView function. The left and right shift key combination is particularly suitable for extended keyboards where additional keys can be programmed to act as a combination of other keys. Such keyboards are supplied with many Gateway 2000 computers. Programming spare keys to trigger the hotkey combination allows channels to be selected via a single key stroke.

- H1 - 'CTRL' and 'ALT' keys together (left or right hand keys operate) (default)
- H2 - 'CTRL' and 'SHIFT' keys together (left or right hand keys operate)
- H3 - 'ALT' and 'SHIFT' keys together (left or right hand keys operate)
- H4 - 'RIGHT ALT' key
- H5 - 'LEFT ALT' and 'RIGHT ALT' keys together
- H6 - 'LEFT CTRL' and 'LEFT ALT' keys together
- H7 - 'RIGHT CTRL' and 'RIGHT ALT' keys together
- H8 - No hotkey enabled

4.6 Firmware functions (version query, mouse restore and reset)

For technical support purposes, it may be necessary to find the firmware release version for the control software in your SmartView. For example, if the release version is v1.02 the response shown to F1(enter) will be a brief display of the digit '1', then F2(enter) will be a brief display of the digit '0', then F3(enter) will be a brief display of the digit '2'. You can reset all of the configured options back to the factory default states by typing F8. Use options F5 and F6 to restore mouse function on disconnected PS/2 CPU mouse connections. See section 2.9 for full details.

F1 - Display firmware first digit

F2 - Display firmware second digit

F3 - Display firmware third digit

F5 - Restore PS/2 mouse function to the currently selected CPU's mouse port

F6 - Restore IntelliMouse function to the currently selected CPU's mouse port

F8 - Reset all configurations to factory default settings. An 'r' will show briefly on the display to confirm that the reset has been completed.

4.7 Display appearance options

Options are available to change the colour scheme of the On-Screen Display and the time that the confirmation message remains on the screen after a channel has been selected.

D1 - Menu appears with magenta / blue background and green highlight (default)

D2 - Menu appears with red / blue background and green highlight

D3 - Menu appears with blue / black background and light blue highlight

D4 - Confirmation message remains on screen for standard time period (default)

D5 - Confirmation message remains on screen for short time period

D6 - Confirmation message remains on screen for extended time period

4.8 Setting a security password

There are many situations where unrestricted access to corporate file servers or sensitive information needs to be controlled. In such circumstances, the SmartView can be locked away in a room or secure cabinet and controlled remotely. In this mode typing the keyboard hotkeys together with 0 will blank the screen, disconnect the keyboard and mouse from all of the computers and display 'P' on the SmartView display. Control can only be regained by typing the correct password on the keyboard.

To set the password in configure mode, first type 'P' then (enter). The display on SmartView will change to show '=' and you can then type your password. The password is not case sensitive and can be any combination of key strokes, including the function keys, but excluding the (ctrl), (alt), (shift) and (enter) keys. When you have typed in your password type (enter) to register it in the stored memory. Do not worry if you type the password incorrectly, you can always re-enter configure mode and set the password again. If you have mistyped, forgotten or lost the password and the SmartView Pro is locked then you can clear the password by entering configure mode at power on. Note that under these circumstance you will not be able to enter configure mode after the unit has powered on because it will ask you to enter the password.

NOTE - The password consists of a combination of key strokes rather like the code to a safe. The key strokes are not case sensitive and can include all the keys on the keyboard (except ctrl, alt, shift and enter). Consequently the following 'password' would be valid:



4.9 Cascade query code

The SmartViews use a special 'query code' to detect whether or not they are connected to another SmartView. By default your SmartView Pro uses query code AD. SmartView Pro units with firmware versions less than 1.09 and SmartView units with firmware version less than 1.18 used query code EF. This was found to conflict with a small number of other (rare) devices that used the same query code so an alternative query code was provided to ensure compatibility. Either query code may be used but you should make sure that all cascaded SmartView units are set to use the same query code. If any of the cascaded SmartView Pros have firmware versions less than 1.09 then the cascade query code for all the SmartView Pros should be set to EF.

L7 – Cascade query code = AD (default)

L8 – Cascade query code = EF

4.10 Exit configure mode

When you have finished configuring any special options, simply type 'E' followed by (enter) to exit configure mode and return to normal operation mode. The attached computers can now be switched on.

Appendix A. Cable and connector specifications

IMPORTANT NOTE

The maximum cable lengths supported vary widely between devices and cables. It may be possible to use cables that are longer than those specified below with certain PCs and peripherals but this cannot be guaranteed. If you experience problems try using shorter cables.

A1. Keyboard, monitor and mouse to SmartView

Cable specification:

All of the shared devices plug directly into the relevant ports at the rear of the SmartView. If you use an AT style keyboard you will need an AT (5 pin DIN female) to PS/2 (6 pin mini-DIN male) converter. Keyboard, monitor and mouse extension cables can be used to increase the distance from SmartView up to 10m. Most keyboards and mice will also operate at distances of 20 metres.

A2. SmartView to PCs 1 to 16

Cable specifications:

Video - 15 pin high density male D connector to 15 pin high density male D connector wired as a standard VGA PC to monitor cable. There are two types commonly available. The best type cables which will give excellent quality are constructed with coaxial cable cores. Cheaper 'data' cables are often used, but can degrade video quality if used over longer distances. Avoid using 'data' cables longer than 2 metres unless the video quality is not important. Good quality coaxial video cables may be run at distances up to 50 metres with little loss of video quality.

Keyboard and PS/2 mice - 6 pin mini-DIN male connector to 6 pin mini-DIN male connector with all lines connected straight through (1-1,2-2 etc.). If the PC has a 5-pin DIN AT style keyboard connector you will need a PS/2 to AT keyboard adapter 6-pin mini-DIN female to 5-pin DIN male (readily available). Cables should be no longer than 30 metres.

RS232 serial mice - these require a special converter to connect the RS232 lines present on the SmartView mouse ports to the RS232 port on a PC.

6 pin mini-DIN female
takes cable from SmartView

9 pin D female
plugs into PC serial port

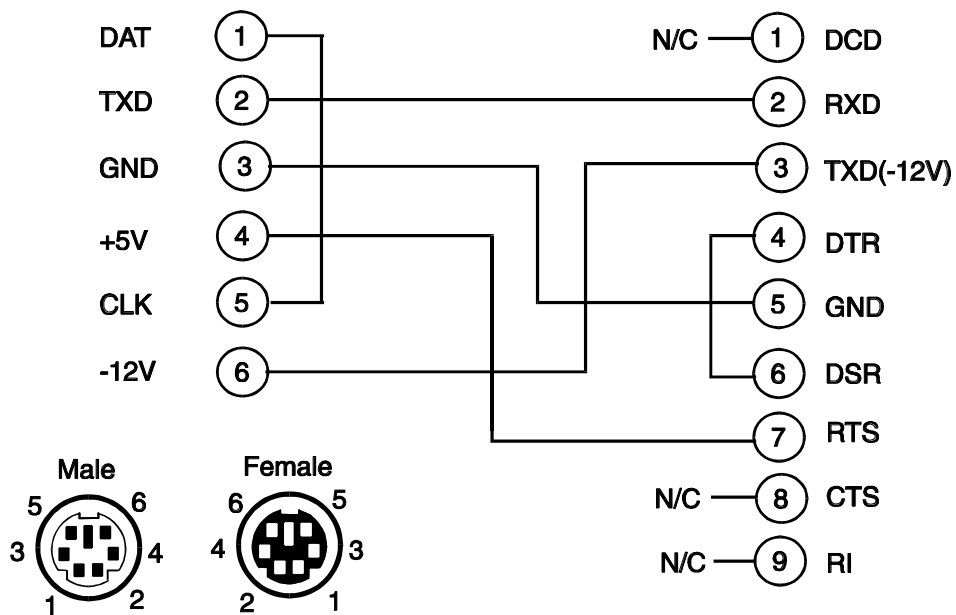

Cables should be no longer than 30 metres.

A3. Expansion port pin assignments

The 15 way D connector located on the back of the SmartView provides connections for the remote control module and allows an external RS232 device to control the SmartView. See section 3.5 for more details.

Pin 9 = GND

Pin 11 = RXD

Other pins to be left unconnected

Appendix B. Problem Solving

Problem:

Poor video quality with smearing fuzziness or ripple.

Action:

Use screened coaxial video cables to connect your devices to the SmartView.

Problem:

Mouse does not move cursor on screen.

Action:

Ensure that the mouse and computer are both connected to SmartView before power is connected and ensure that the SmartView is powered on before the attached computer. Ensure that your software is configured to accept a Microsoft compatible mouse of the type that you have connected (PS/2 or RS232). If you move the mouse and the activity indicator (dot on 7 segment display) does not flash then the SmartView is not receiving data from the mouse. Check the mouse connection to the SmartView, try resetting the mouse using the reset function (section 3.3) or re-powering the SmartView. If you are attempting to connect the SmartView to a CPU with a PS/2 mouse connection that has not been powered down then you will need to use the mouse restoration functions F5 or F6 (see section 2.9).

Problem:

Keyboard does not function or functions intermittently. Num lock light does not always come on when the num lock key is pressed.

Action:

Some older keyboards were designed for use with specific computers and are not truly AT or PS/2 compatible. These are not common but if you experience problems try another keyboard.

Problem:

Mouse causes channel to change.

Action:

Some cheaper mice are not fully compatible with the SmartView and can lose data causing the channel to be changed (if mouse switching of channels is enabled). If you experience this problem then change the mouse and use a Microsoft, Logitech, IBM, Compaq or Hewlett-Packard type. Ensure that you are using a Microsoft compatible mouse driver on your PC. Some other manufacturers' drivers may switch the mouse to use a proprietary mouse data format not supported by the SmartView. If you have unplugged and re-connected a mouse to the SmartView then ensure that you reset it using the mouse reset function (see section 3.3).

Problem:

Mouse jumps around the screen after disconnecting the mouse cable or powering down the SmartView.

Action:

If you have disconnected and re-connected a CPU mouse cable or you have powered down the SmartView then the mouse data format may be out of synchronisation with that required by the PC (PS/2 or Intellimouse). Try the 'restore Intellimouse' function (F6) to resolve the problem or re-power the CPU.

Problem:

SmartView does not power on correctly (display is blank or stuck after power on).

Action:

Switch the SmartView off and leave for 10 seconds. Re-power the SmartView, preferably from a switch on a wall socket rather than by plugging in the connector to the rear panel of the SmartView. Try switching off all the connected CPUs and switching on the SmartView first. If this action does not resolve the problem then there is a fault with the SmartView.

Problem:

Video appears to be lost after a PC has gone into auto power down mode. Moving the mouse and typing at the keyboard does not wake it up.

Action:

Some computers tested output an incomplete video signal in auto power down mode. The on-screen menu cannot 'lock on' to this signal and so cannot be displayed under these conditions. If the Adder menu is left on the screen and this type of auto power down occurs then the screen becomes blank. Keyboard and mouse data is captured by the menu process and so is not sent to the computer to cause it to wake up. The operation therefore appears to 'hang'. To restore the video under these conditions press escape, return or change the channel using HOTKEYS + channel number. Alternatively, you may wish to avoid leaving the menu on the screen if you have a PC that exhibits this anomaly.

Problem:

Mouse consistently fails to boot when using a Compaq integrated keyboard / mouse model MX11800 with the SmartView, Windows NT 4.0 and a PS/2 connection to some types of PCs.

Action:

There are three possible solutions to this problem: 1) Use a different mouse. 2) Connect the SmartView mouse connection to a serial port on the NT 4.0 unit rather than the PS/2 port. 3) Select channel 0 or a port that is not connected to an NT 4.0 box whilst NT is booting. Use the system normally once the logon screen appears.

Notes

SMART View **PRO**

INSTALLATION & USE



ADDER Technology Limited

Technology House

Trafalgar Way

Bar Hill

Cambridge

CB3 8SQ • England

T: +44 (0) 1954 780044

F: +44 (0) 1954 780081

sales@addertec.com

www.addertec.com